

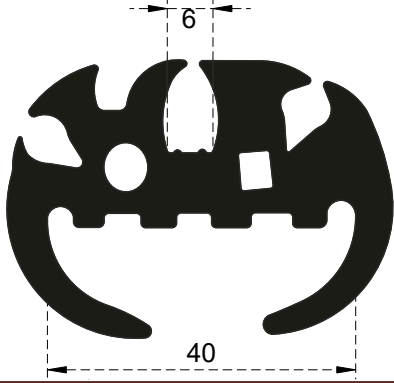

• otobüs-minibüs yan cam lastikleri

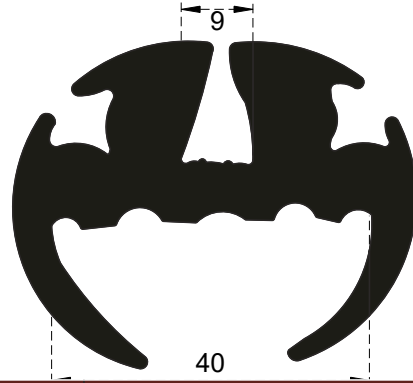

PK CODE 10-1001



PK CODE 10-1002

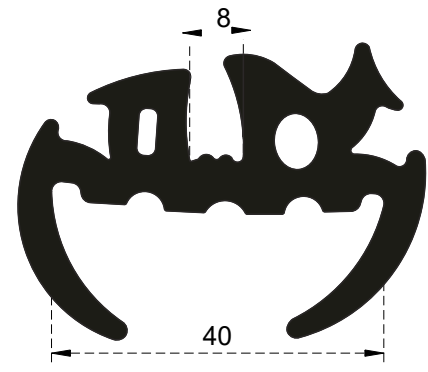

PK CODE 10-1003

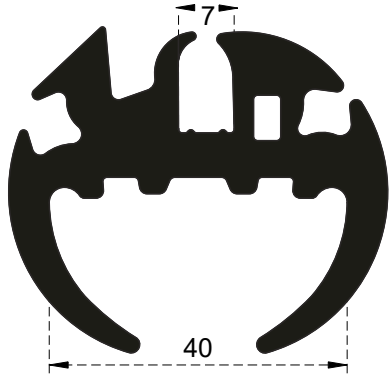

PK CODE 10-1004

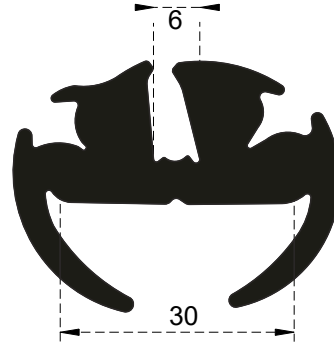

PK CODE 10-1005

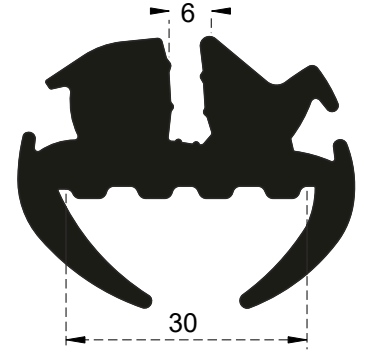

PK CODE 10-1006

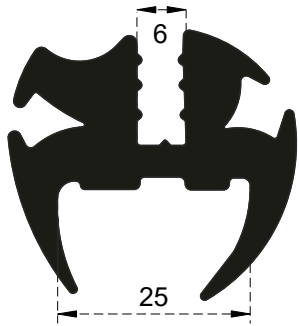

PK CODE 10-1007

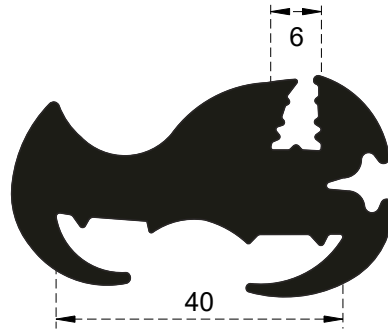

PK CODE 10-1008

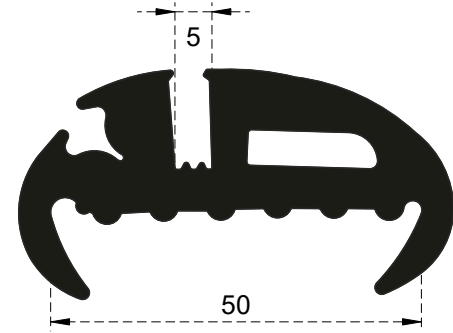

PK CODE 10-1009

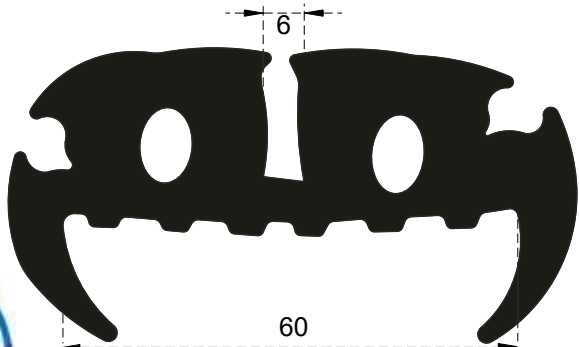

PK CODE 10-1010

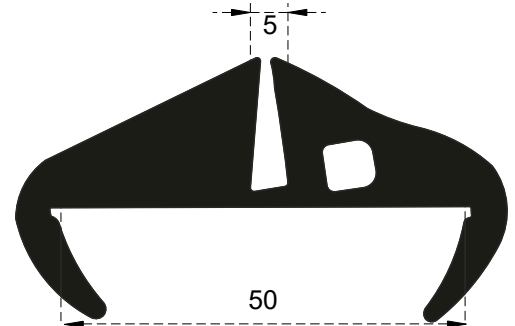

PK CODE 10-1011



• otobüs-minibüs yan cam lastikleri

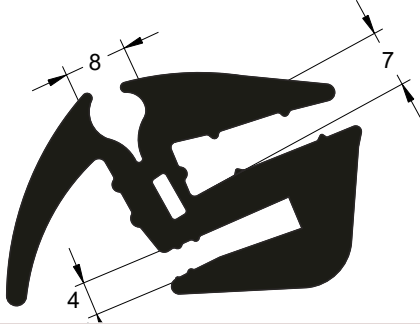

PK CODE

10-1012

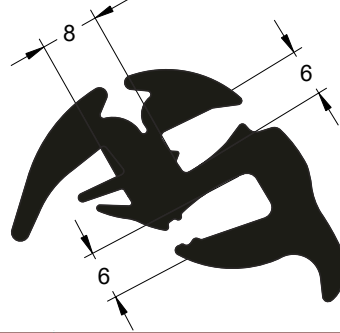

PK CODE

10-1013

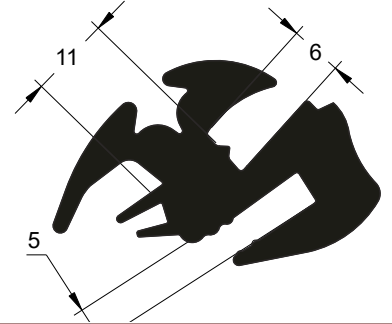

PK CODE

10-1014

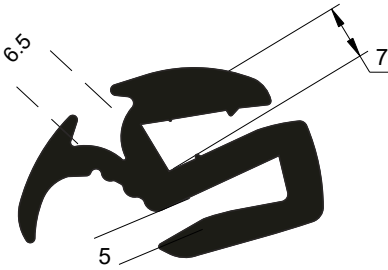

PK CODE

10-1015

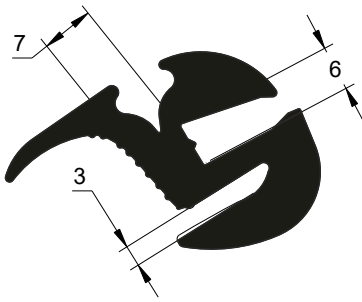

PK CODE

10-1016

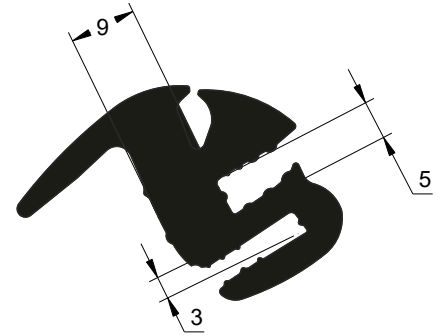

PK CODE

10-1017

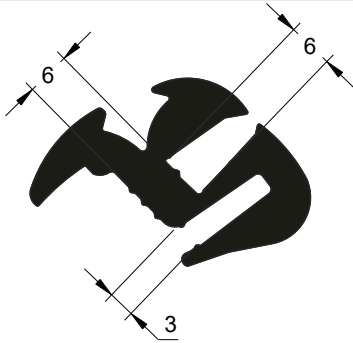

PK CODE

10-1018

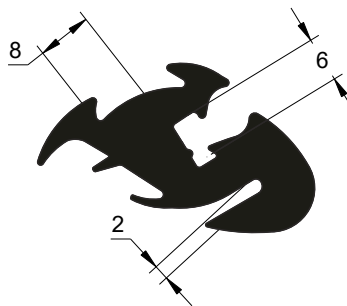

PK CODE

10-1019

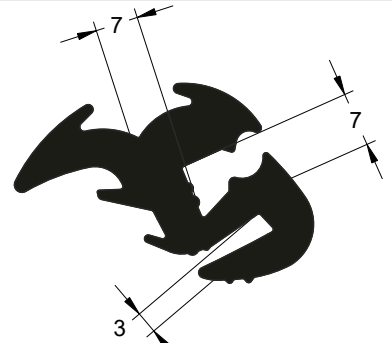

PK CODE

10-1020

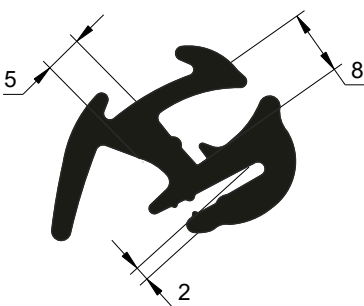

PK CODE

10-1021

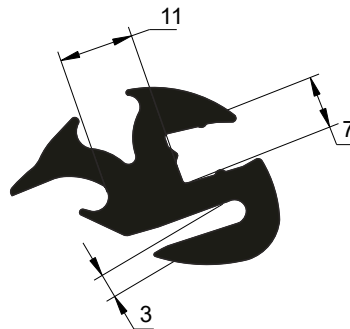

PK CODE

10-1022

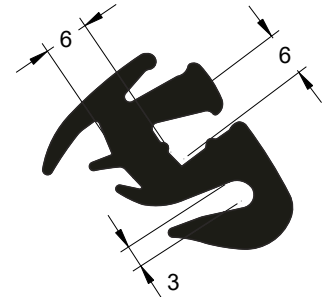

PK CODE

10-1023

• otobüs-minibüs yan cam lastikleri

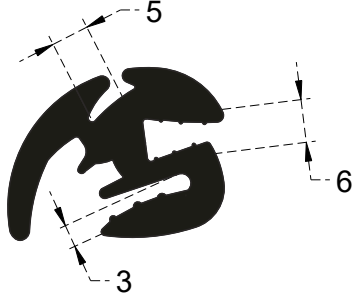

PK CODE **10-1024**

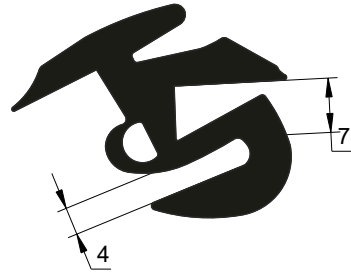

PK CODE **10-1025**

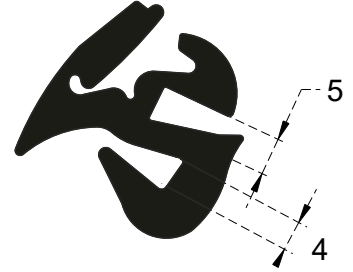

PK CODE **10-1026**

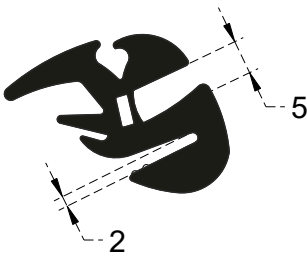

PK CODE **10-1027**

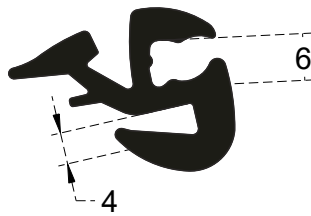

PK CODE **10-1028**

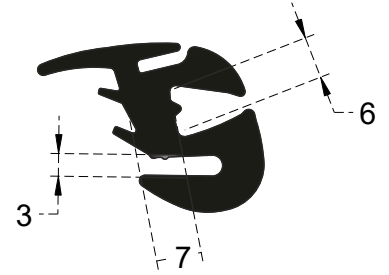

PK CODE **10-1029**

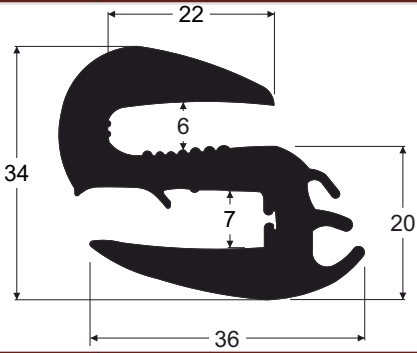

PK CODE **10-1030**

PK CODE **10-1031**

PK CODE **10-1032**

PK CODE **10-1033**

PK CODE **10-1034**

PK CODE **10-1035**

• otobüs-minibüs yan cam lastikleri

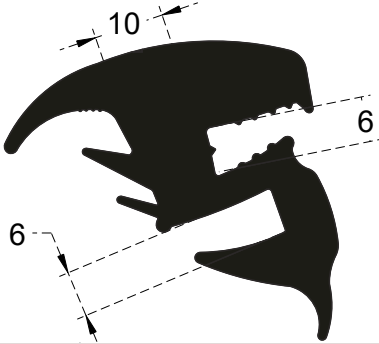

PK CODE

10-1036

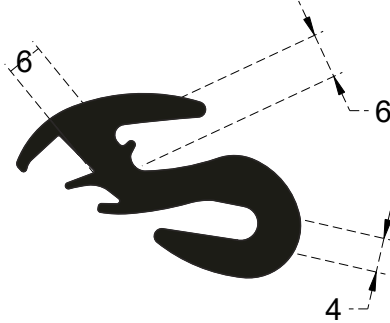

PK CODE

10-1037

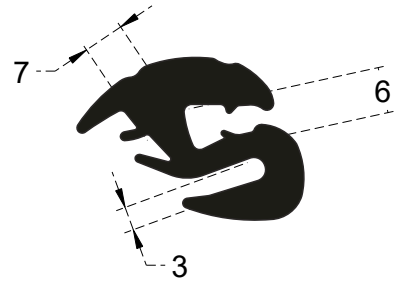

PK CODE

10-1038

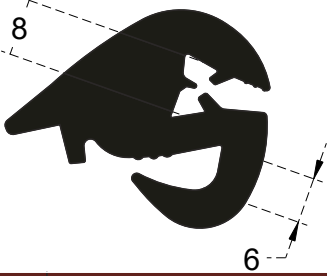

PK CODE

10-1039

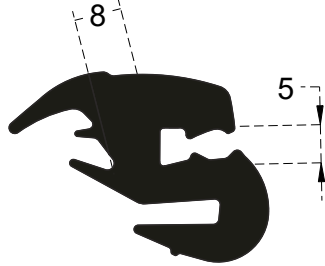

PK CODE

10-1040

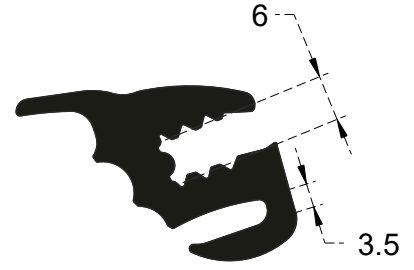

PK CODE

10-1041

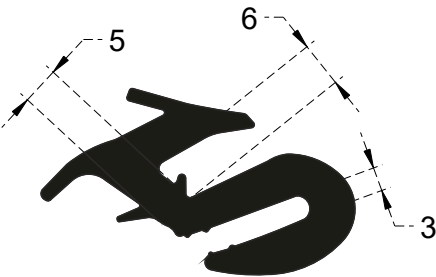

PK CODE

10-1042

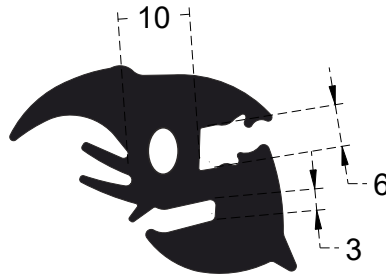

PK CODE

10-1043

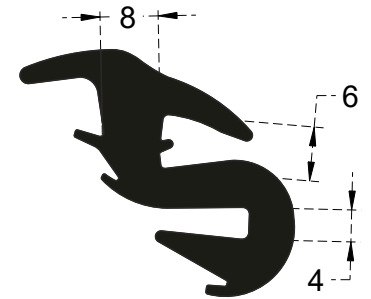

PK CODE

10-1044

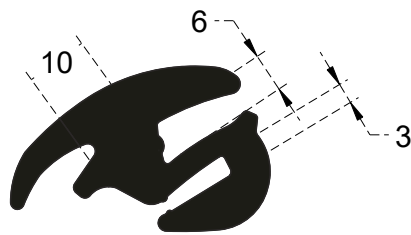

PK CODE

10-1045

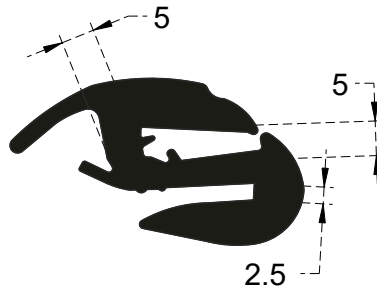

PK CODE

10-1046

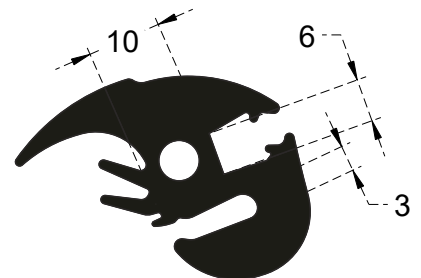

PK CODE

10-1047

• otobüs-minibüs yan cam lastikleri

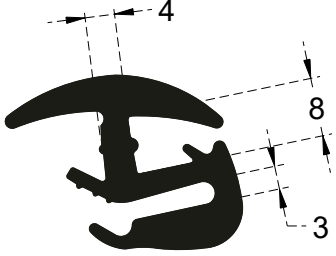

PK CODE

10-1048

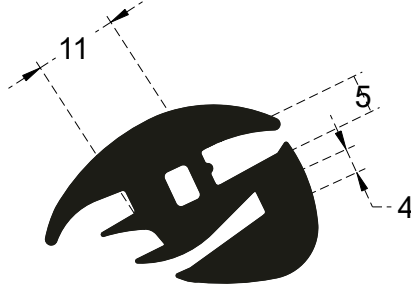

PK CODE

10-1049

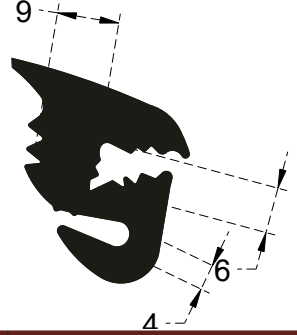

PK CODE

10-1050

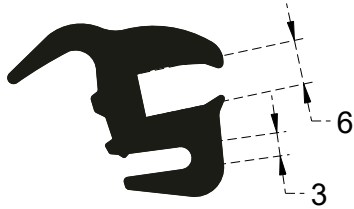

PK CODE

10-1051

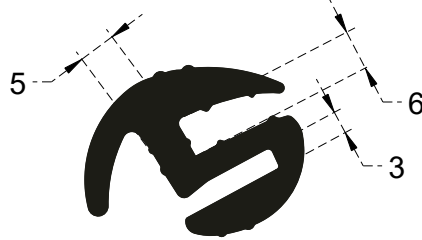

PK CODE

10-1052

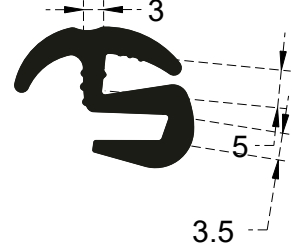

PK CODE

10-1053

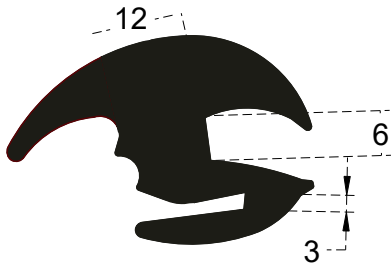

PK CODE

10-1054

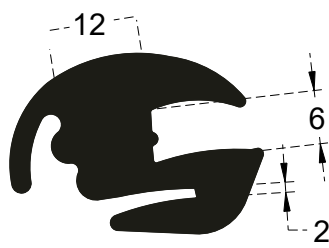

PK CODE

10-1055

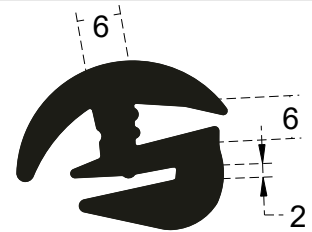

PK CODE

10-1056

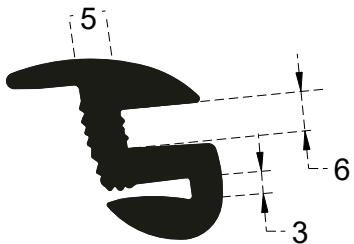

PK CODE

10-1057

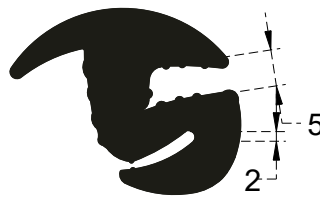

PK CODE

10-1058

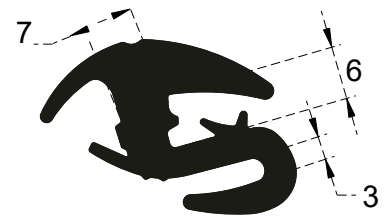

PK CODE

10-1059

• otobüs-minibüs yan cam lastikleri

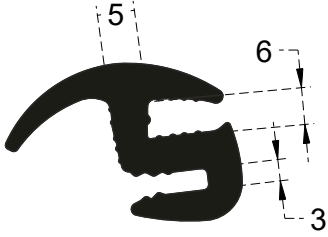

PK CODE

10-1060

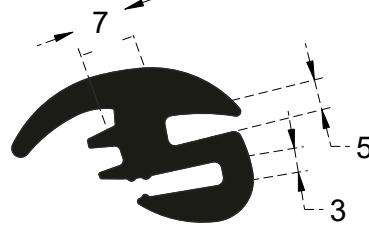

PK CODE

10-1061

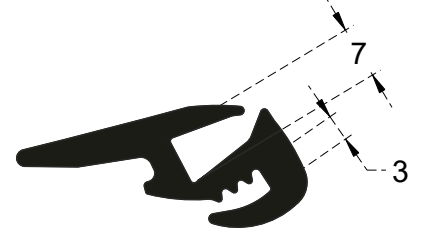

PK CODE

10-1062

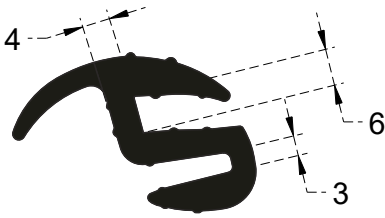

PK CODE

10-1063

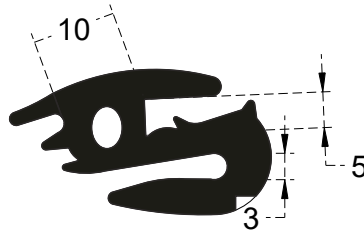

PK CODE

10-1064

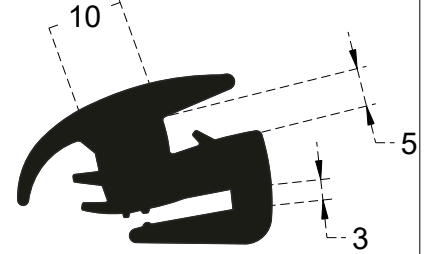

PK CODE

10-1065

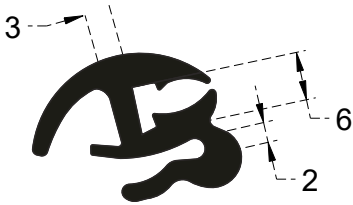

PK CODE

10-1066

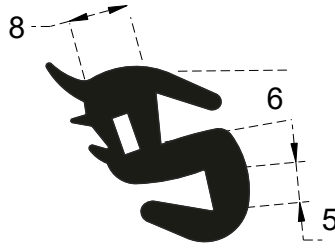

PK CODE

10-1067

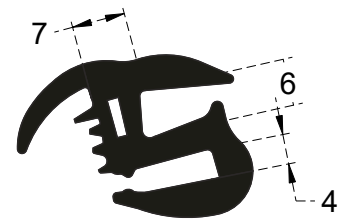

PK CODE

10-1068

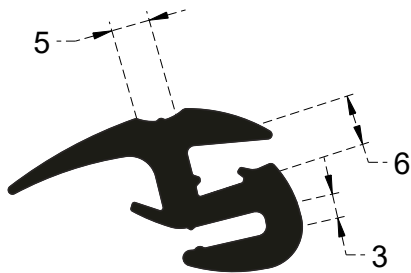

PK CODE

10-1069

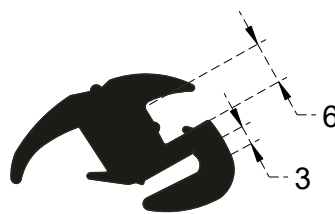

PK CODE

10-1070

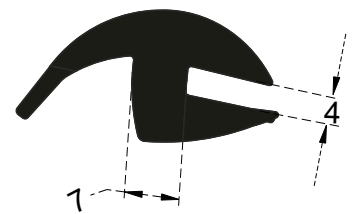

PK CODE

10-1071

• otobüs-minibüs yan cam lastikleri

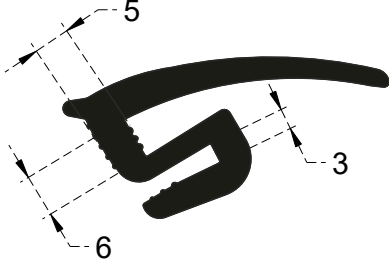

PK CODE

10-1072

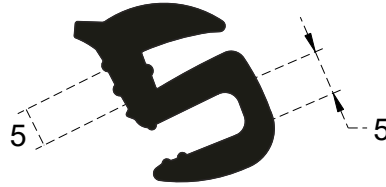

PK CODE

10-1073

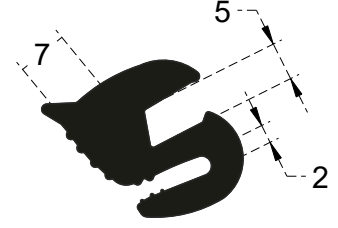

PK CODE

10-1074

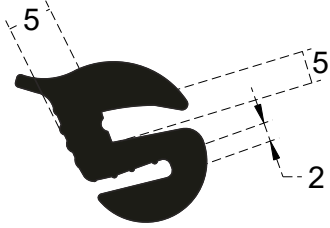

PK CODE

10-1075

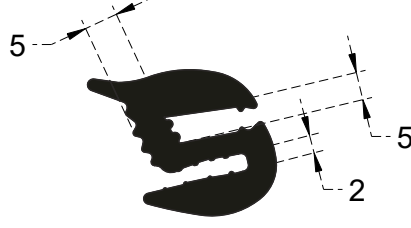

PK CODE

10-1076



PK CODE

10-1077

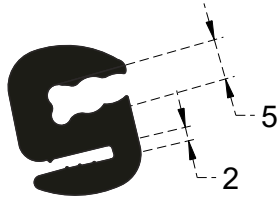

PK CODE

10-1078

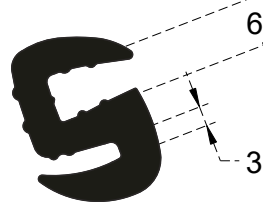

PK CODE

10-1079

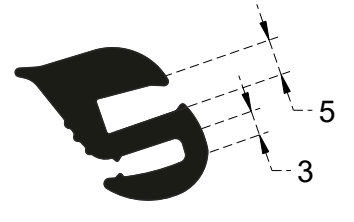

PK CODE

10-1080

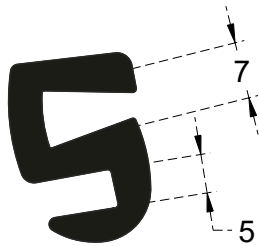

PK CODE

10-1081

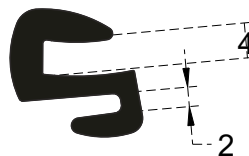

PK CODE

10-1082

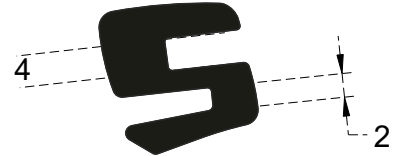

PK CODE

10-1083

• otobüs-minibüs yan cam lastikleri

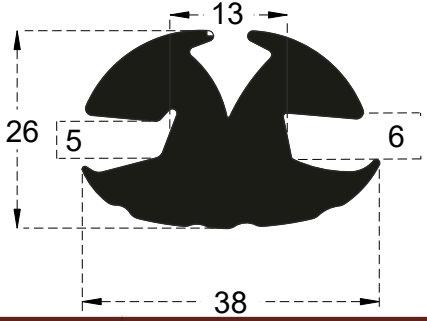

PK CODE 10-1084

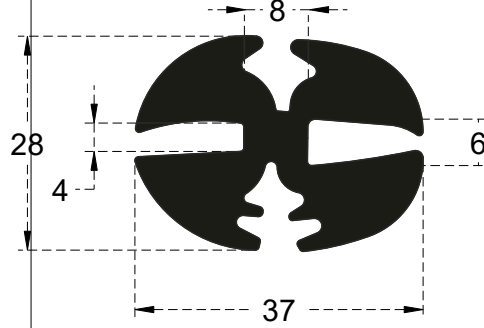

PK CODE 10-1085

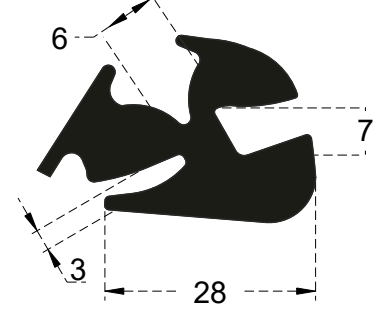

PK CODE 10-1086

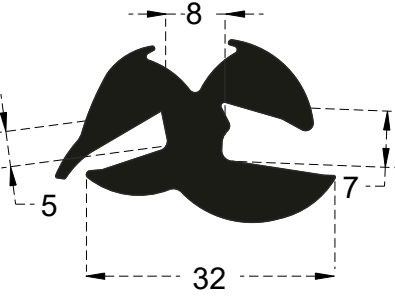

PK CODE 10-1087

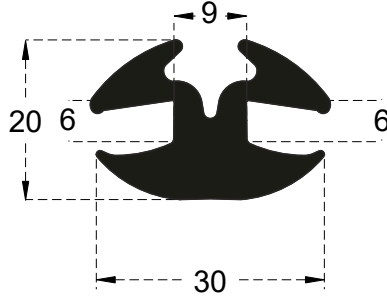

PK CODE 10-1088

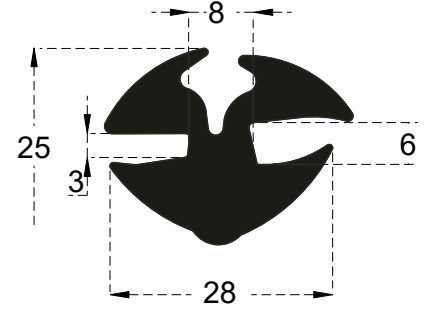

PK CODE 10-1089

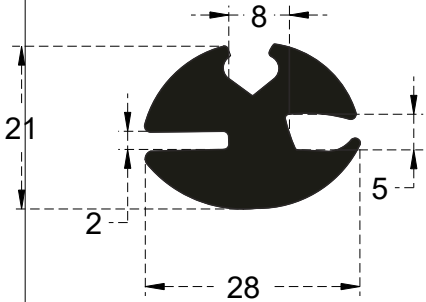

PK CODE 10-1090

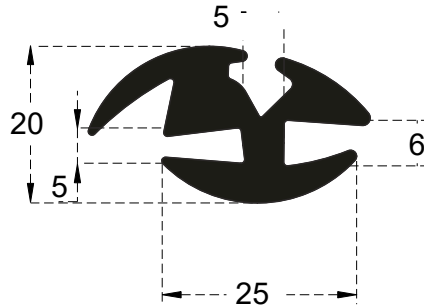

PK CODE 10-1091

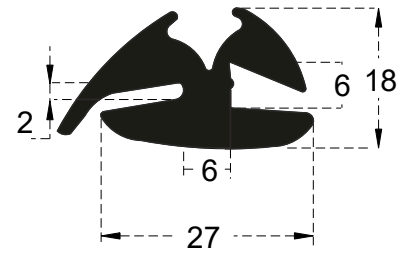

PK CODE 10-1092

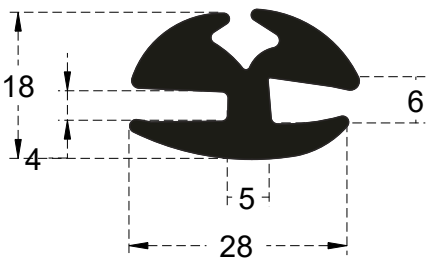

PK CODE 10-1093

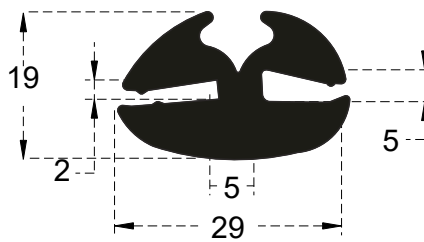

PK CODE 10-1094

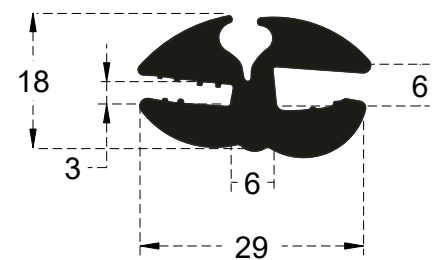

PK CODE 10-1095

• otobüs-minibüs yan cam lastikleri

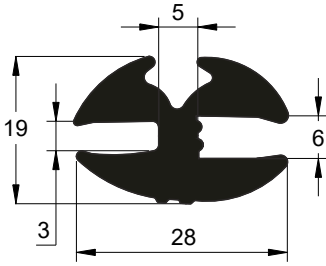

PK CODE

10-1096

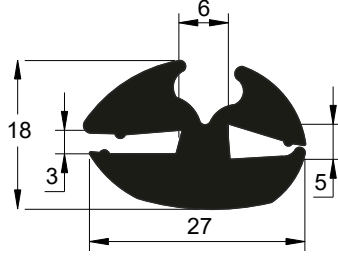

PK CODE

10-1097

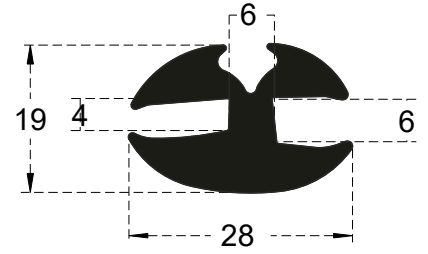

PK CODE

10-1098

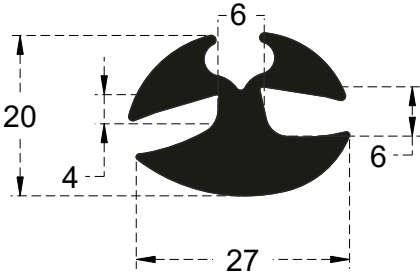

PK CODE

10-1099

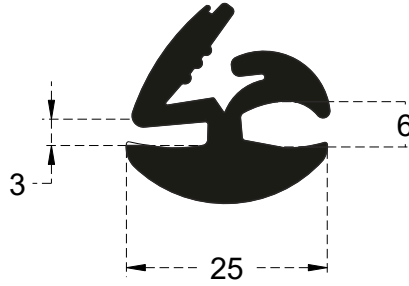

PK CODE

10-1100

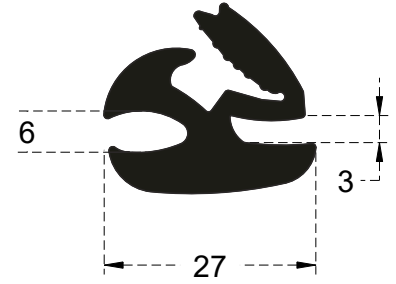

PK CODE

10-1101

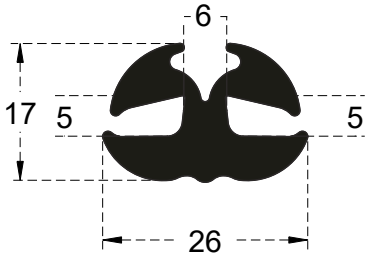

PK CODE

10-1102

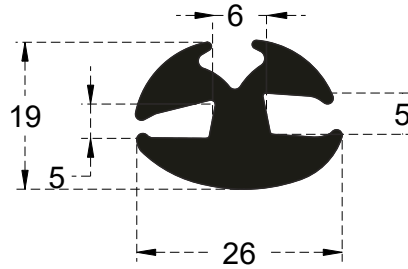

PK CODE

10-1103

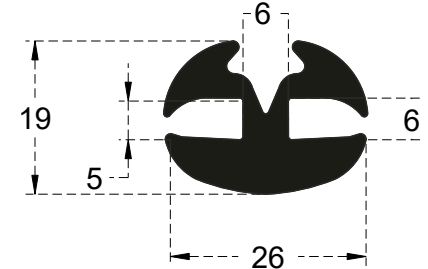

PK CODE

10-1104

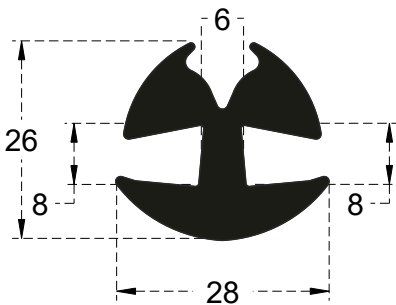

PK CODE

10-1105

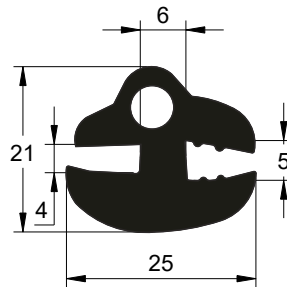

PK CODE

10-1106

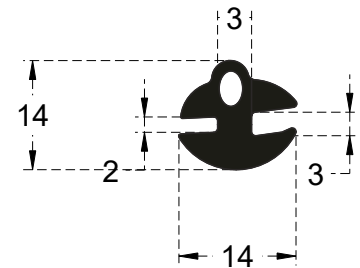

PK CODE

10-1107

• otobüs-minibüs yan cam lastikleri

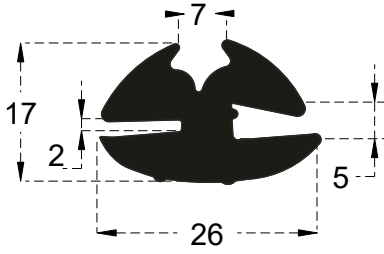

PK CODE 10-1108

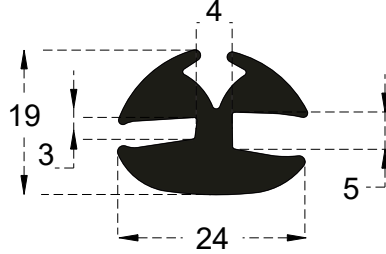

PK CODE 10-1109

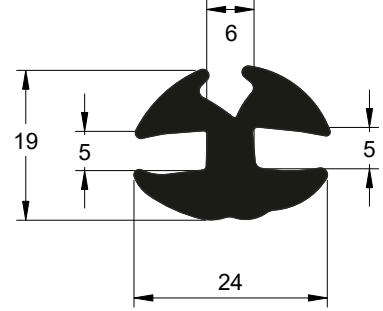

PK CODE 10-1110

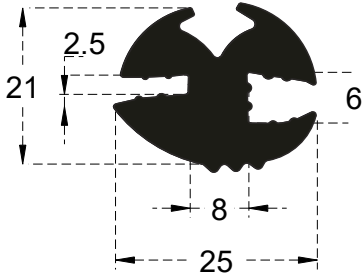

PK CODE 10-1111

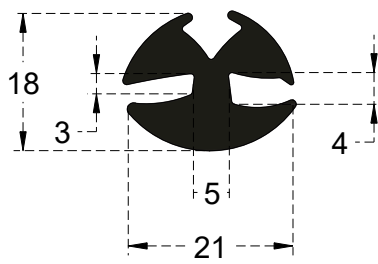

PK CODE 10-1112

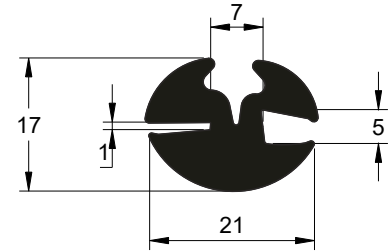

PK CODE 10-1113

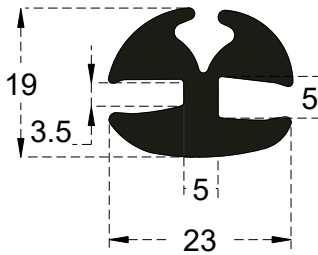

PK CODE 10-1114

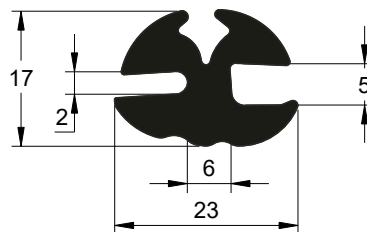

PK CODE 10-1115

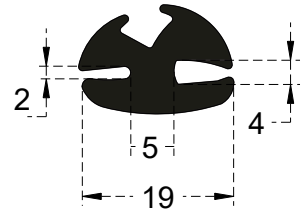

PK CODE 10-1115

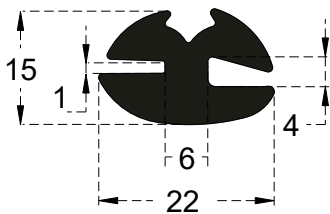

PK CODE 10-1117

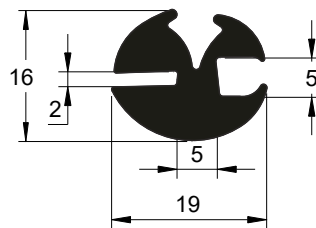

PK CODE 10-1118

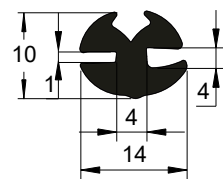

PK CODE 10-1119

• otobüs-minibüs yan cam lastikleri

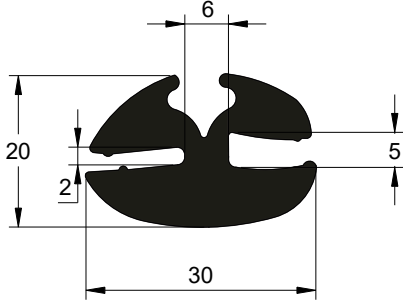

PK CODE

10-1120

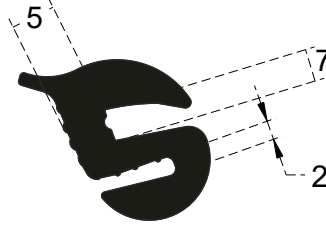

PK CODE

10-1121

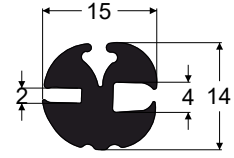

PK CODE

10-1122

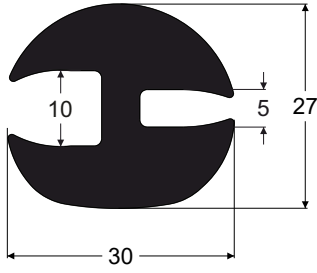

PK CODE

10-1123

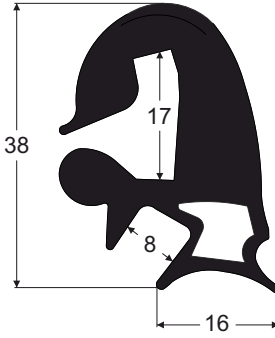

PK CODE

10-1124

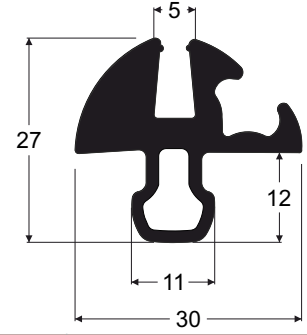

PK CODE

10-1125

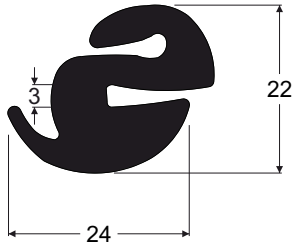

PK CODE

10-1126

PK CODE

PK CODE

PK CODE

PK CODE

PK CODE

- otobüs-minibüs yan cam lastikleri

<small>PK CODE</small>	10-1012	<small>PK CODE</small>	10-1013	<small>PK CODE</small>	10-1014
<small>PK CODE</small>	10-1015	<small>PK CODE</small>	10-1016	<small>PK CODE</small>	10-1017
<small>PK CODE</small>	10-1018	<small>PK CODE</small>	10-1019	<small>PK CODE</small>	10-1020
<small>PK CODE</small>	10-1021	<small>PK CODE</small>	10-1022	<small>PK CODE</small>	10-1023