

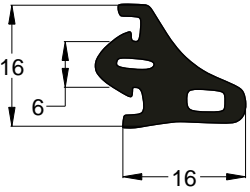

MUHTELİF MAKİNA KAPAK LASTİKLERİ

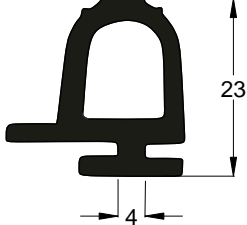
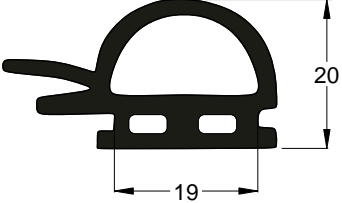
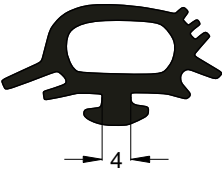
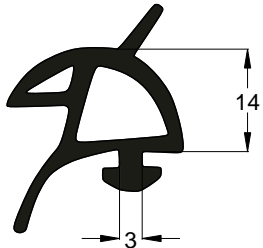
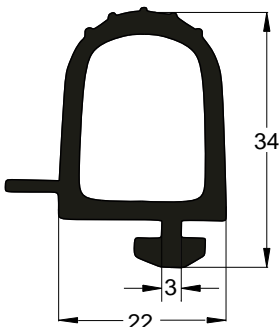
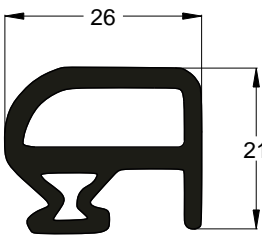
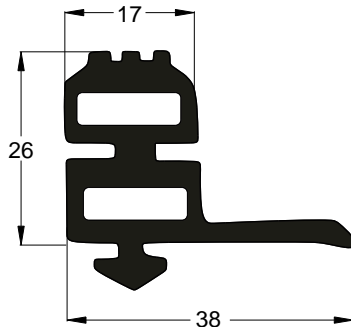
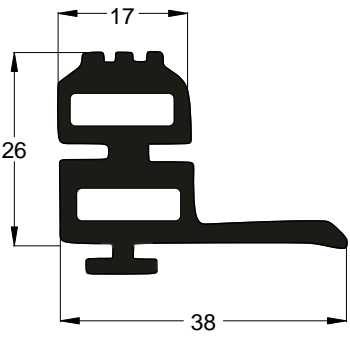
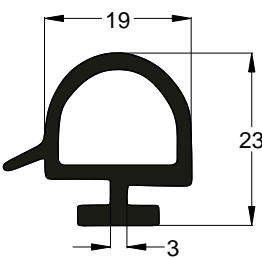
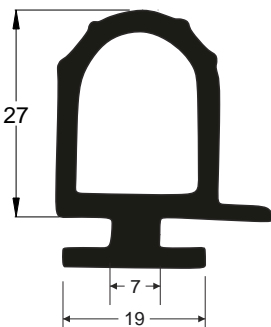

**İpekoğlu otomotiv**
İPEKOĞLU OTOMOTİV

MUHTEL F MAK NA KAPAK LAST KLER

| | | |
|---|---|---|
|  |  |  |
| İPK CODE 14-1001 | İPK CODE 14-1002 | İPK CODE 14-1003 |
|  |  |  |
| İPK CODE 14-1004 | İPK CODE 14-1005 | İPK CODE 14-1006 |
|  |  |  |
| İPK CODE 14-1007 | İPK CODE 14-1008 | İPK CODE 14-1009 |
|  |  |  |
| İPK CODE 14-1010 | İPK CODE 14-1011 | İPK CODE 14-1012 |

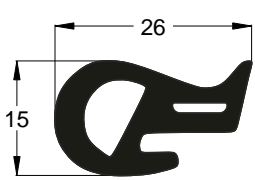
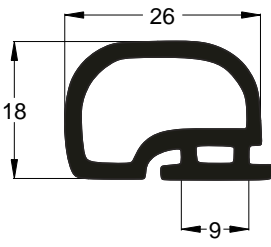
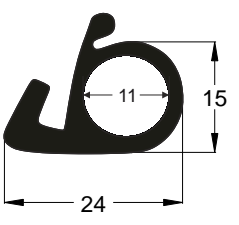
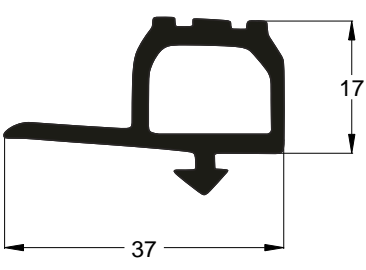
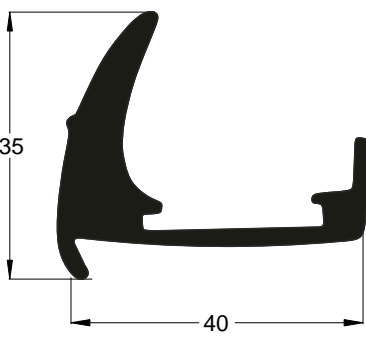
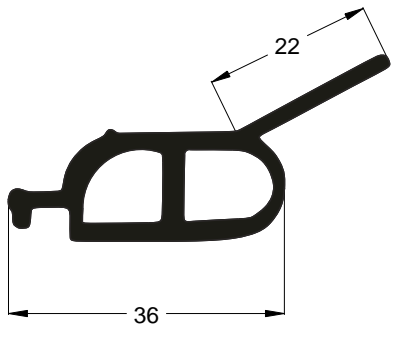
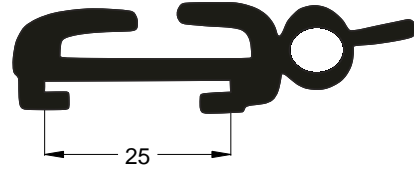
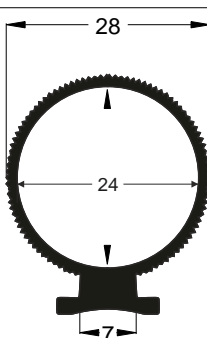
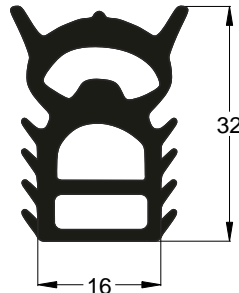
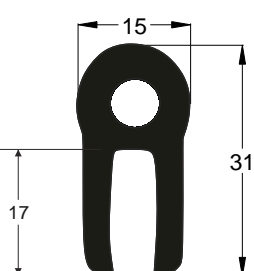
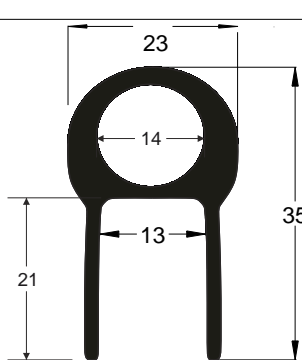
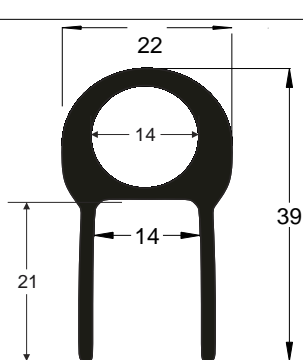

MUHTEL F MAK NA KAPAK LAST KLER

| | | |
|---|---|---|
|  |  |  |
| İPK CODE 14-1013 | İPK CODE 14-1014 | İPK CODE 14-1015 |
| 302 OTOMAT K KAPI CAM | | |
|  |  |  |
| İPK CODE 14-1016 | İPK CODE 14-1017 | İPK CODE 14-1018 |
|  |  |  |
| İPK CODE 14-1019 | İPK CODE 14-1020 | İPK CODE 14-1021 |
|  |  |  |
| İPK CODE 14-1022 | İPK CODE 14-1023 | İPK CODE 14-1024 |

MUHTEL F MAK NA KAPAK LAST KLER

| | | |
|---|--|---|
|  |  |  |
| İPK CODE 14-1025 | İPK CODE 14-1026 | İPK CODE 14-1027 |
| TIPB ATIK CONTA LAST | TIPB ATIK CONTA LAST | |
|  |  |  |
| İPK CODE 14-1028 | İPK CODE 14-1029 | İPK CODE 14-1030 |
| ASANSÖR KAPI LAST | ASANSÖR KAPI LAST | 131 KAPI ALT LAST |
|  |  |  |
| İPK CODE 14-1031 | İPK CODE 14-1032 | İPK CODE 14-1033 |
| OTOMAT K KAPI D REK LAST | OTOMAT K KAPI D REK LAST | OTOMAT K KAPI D REK LAST |

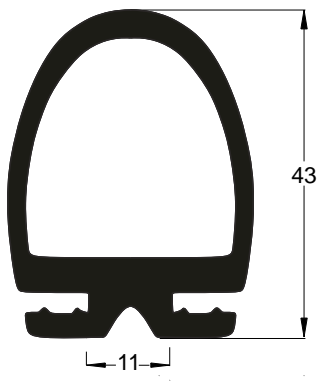
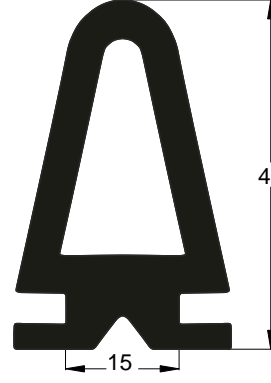
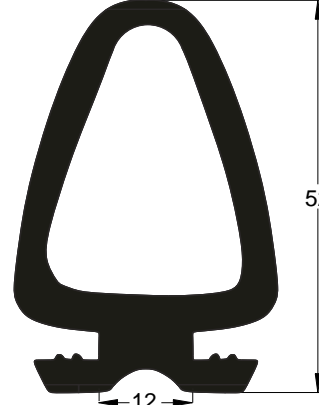
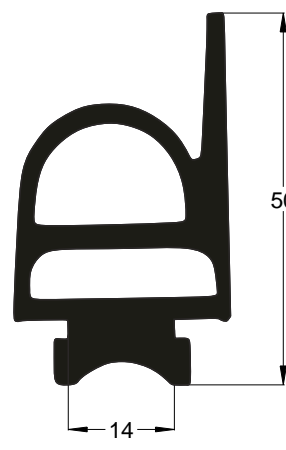

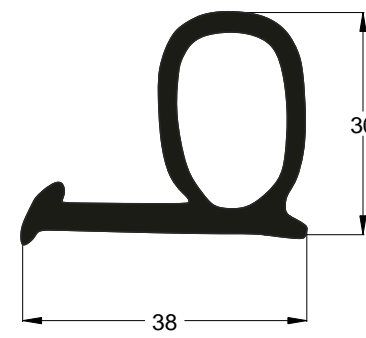
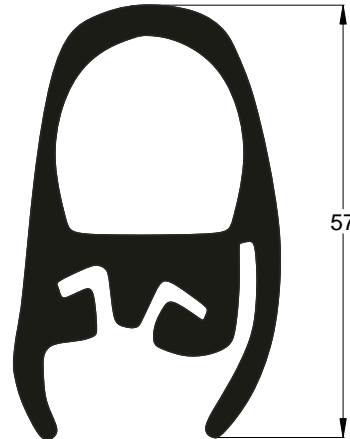
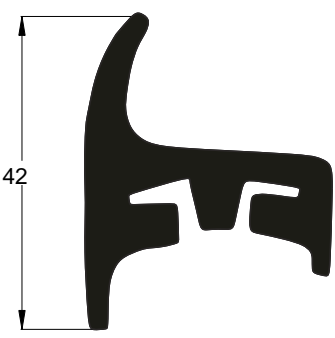
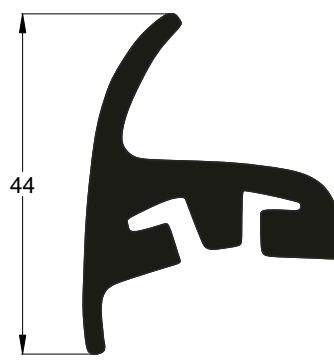

MUHTEL F MAK NA KAPAK LAST KLER

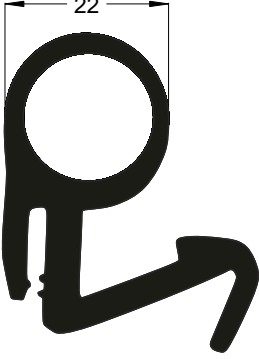
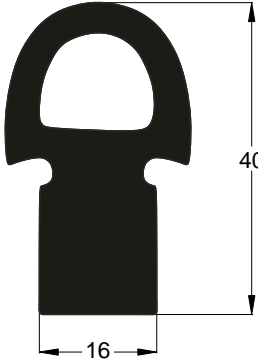
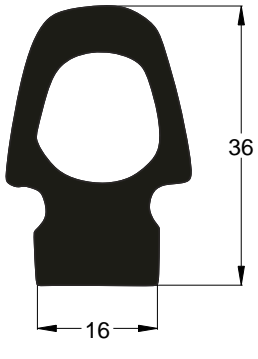
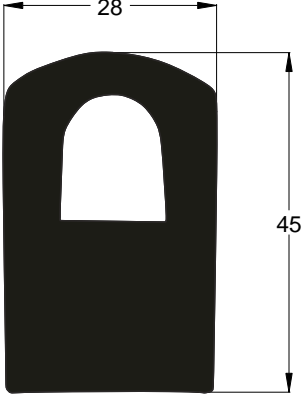
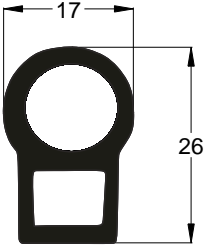
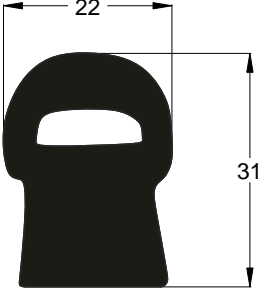
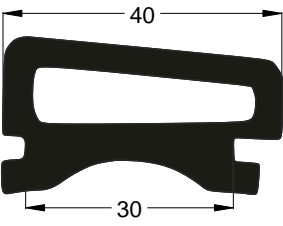
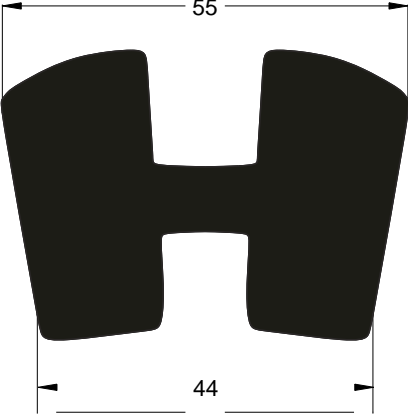
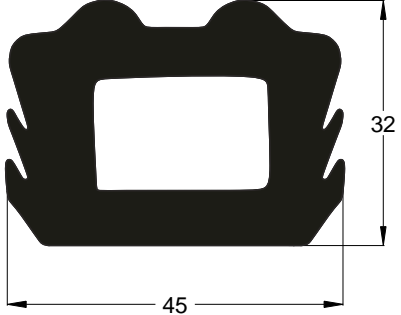
| | | |
|---|---|---|
|  |  |  |
| İPK CODE 14-1034 | İPK CODE 14-1035 | İPK CODE 14-1036 |
| OTOMAT K KAPI D REK LAST | OTOMAT K KAPI D REK LAST | OTOMAT K KAPI D REK LAST |
|  |  |  |
| İPK CODE 14-1037 | İPK CODE 14-1038 | İPK CODE 14-1039 |
| J 9 M N BÜS OTOMAT K KAPI LAS. | OTOMAT K KAPI D REK LAST | 302 OTOMAT K KAPI LAST |
|  |  |  |
| İPK CODE 14-1040 | İPK CODE 14-1041 | İPK CODE 14-1042 |
| 302 OTOMAT K KAPI D REK LAST | 302 OTOMAT K ÇEVRE LAST | 302 OTOMAT K ÇEVRE LAST |

MUHTEL F MAK NA KAPAK LAST KLER

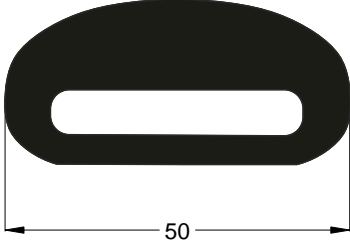
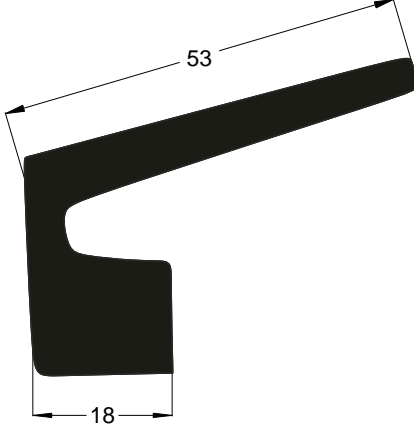
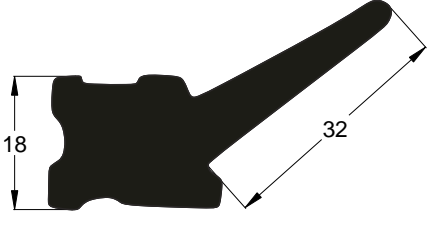
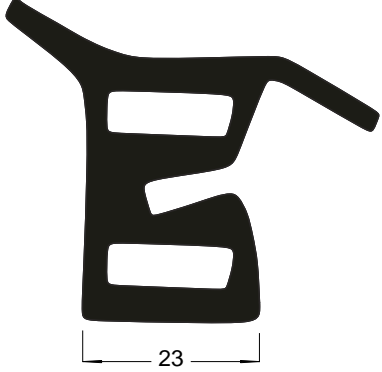
| | | |
|---|--|---|
|  |  |  |
| İPK CODE 14-1043 | İPK CODE 14-1044 | İPK CODE 14-1045 |
| OTOMAT K KAPI LAST | | |
|  |  |  |
| İPK CODE 14-1046 | İPK CODE 14-1047 | İPK CODE 14-1048 |
|  |  |  |
| İPK CODE 14-1049 | İPK CODE 14-1050 | İPK CODE 14-1051 |

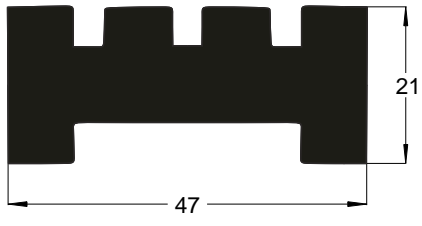
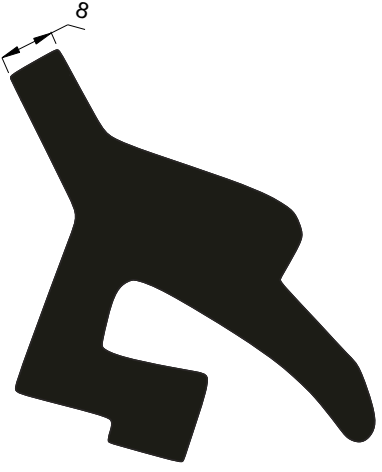
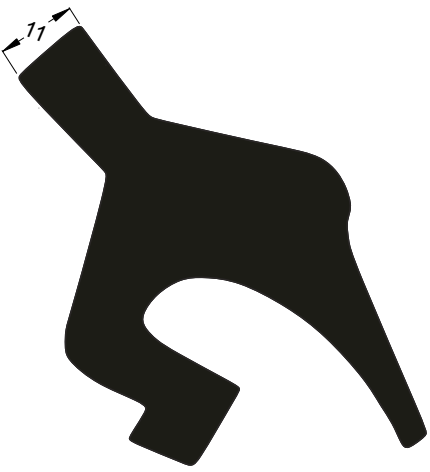
MUHTEL F MAK NA KAPAK LAST KLER

| | | |
|--|---|--|
|  <p>50</p> |  <p>53 18</p> |  <p>18 32</p> |
| <p>İPK CODE 14-1052</p> | <p>İPK CODE 14-1053</p> | <p>İPK CODE 14-1054</p> |
|  <p>23</p> |  <p>58</p> |  <p>21 47</p> |
| <p>İPK CODE 14-1055</p> | <p>İPK CODE 14-1056</p> | <p>İPK CODE 14-1057</p> |
|  <p>8</p> |  <p>7</p> |  <p>60</p> |
| <p>İPK CODE 14-1058</p> | <p>İPK CODE 14-1059</p> | <p>İPK CODE 14-1060</p> |

MUHTEL F MAK NA KAPAK LAST KLER

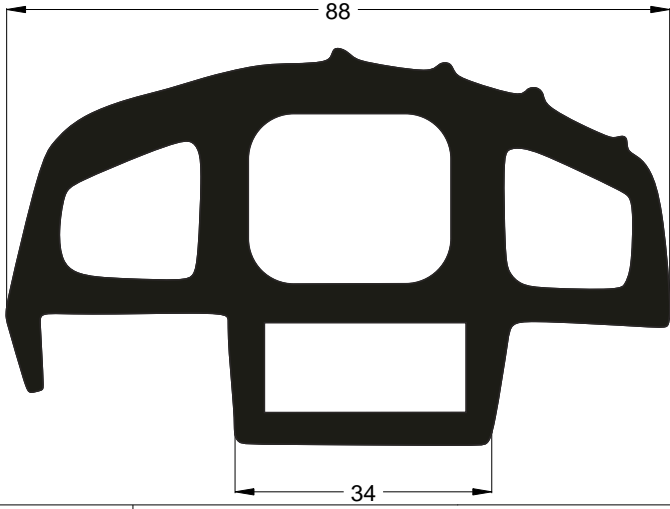

İPK CODE 14-1061

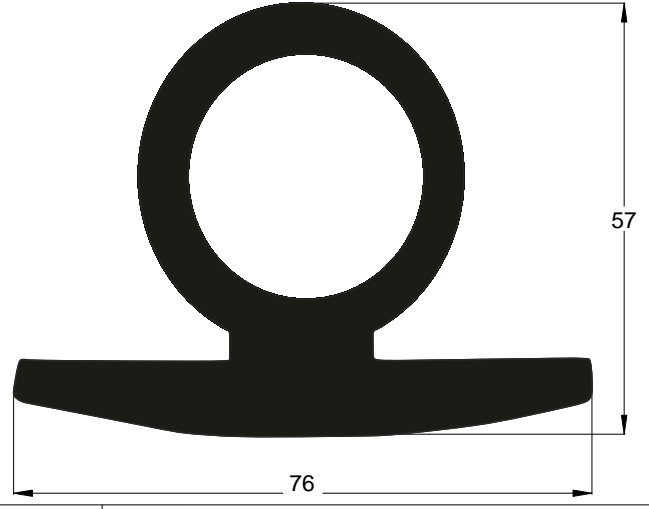

İPK CODE 14-1062

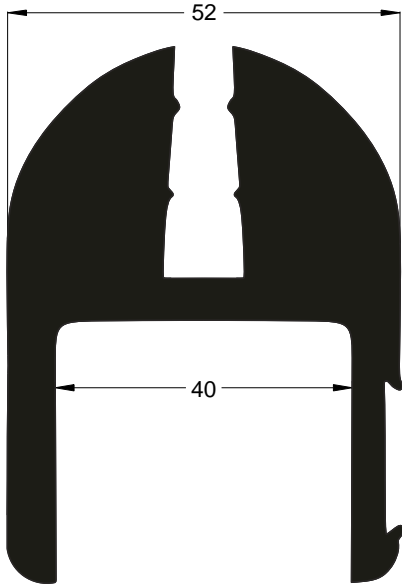

İPK CODE 14-1063

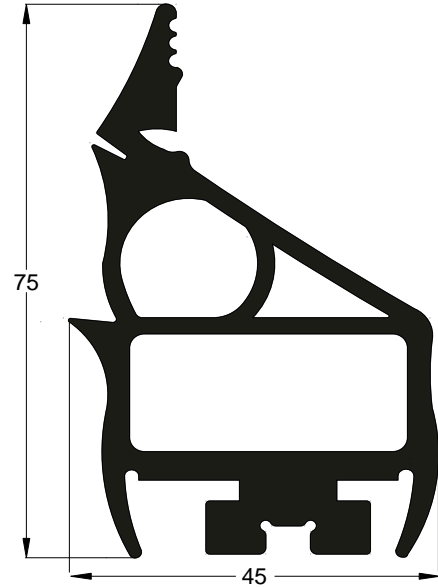

İPK CODE 14-1064

METROBÜS OTOMAT K KAPI D REK LAST

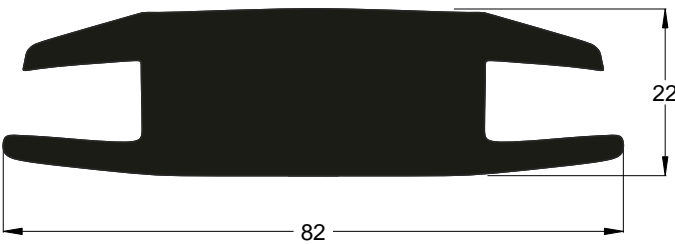

İPK CODE 14-1065

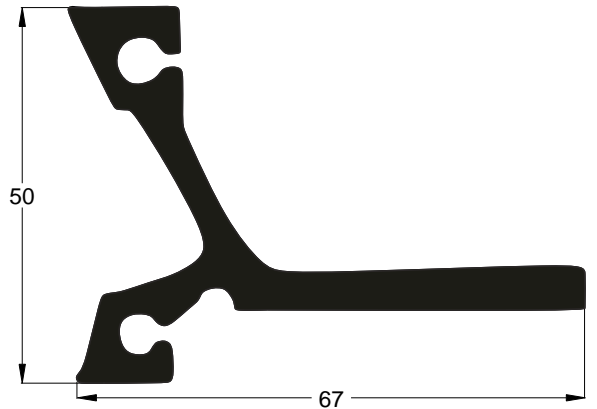

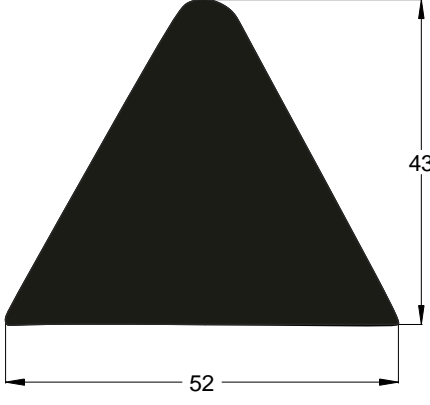
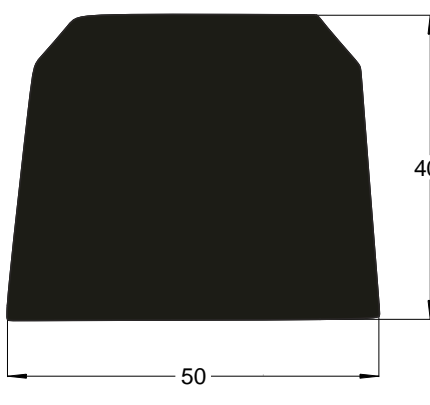
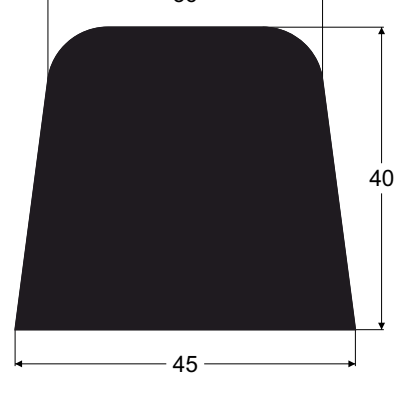
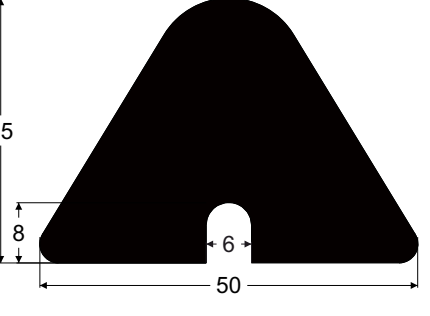
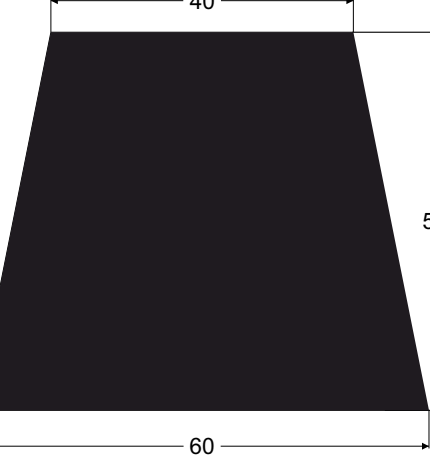
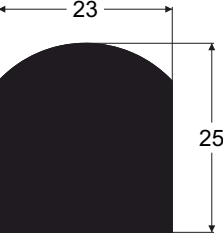
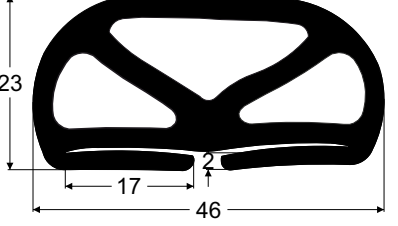
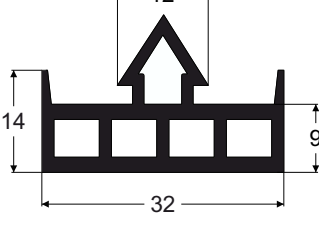
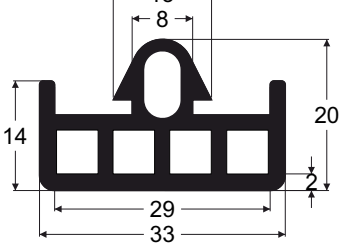

İPK CODE 14-1066

MUHTEL F MAK NA KAPAK LAST KLER

| | | |
|---|---|---|
|  |  |  |
| İPK CODE 14-1067 | İPK CODE 14-1068 | İPK CODE 14-1069 |
|  |  |  |
| İPK CODE 14-1070 | İPK CODE 14-1071 | İPK CODE 14-10672 |
|  |  |  |
| İPK CODE 14-1073 | İPK CODE 14-1074 | İPK CODE 14-1075 |

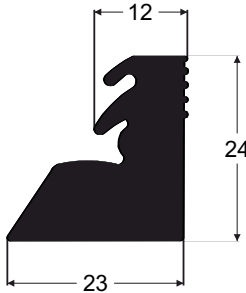
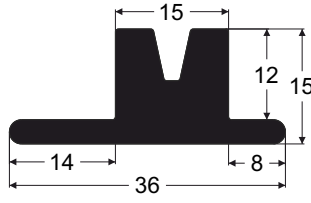
MUHTEL F MAK NA KAPAK LAST KLER

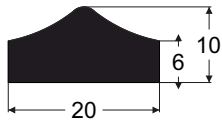
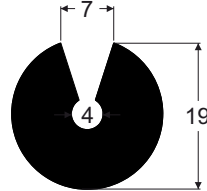
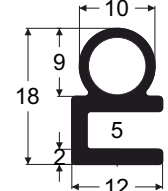
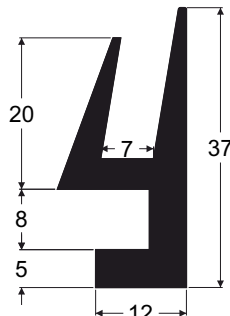
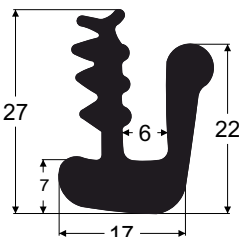
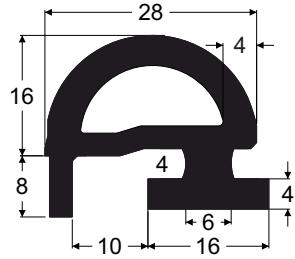
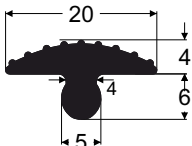
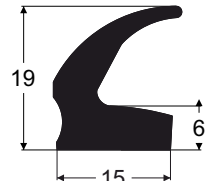
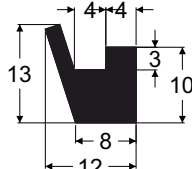
| | | |
|---|---|---|
|  |  |  |
| İPK CODE 14-1076 | İPK CODE 14-1077 | İPK CODE 14-1078 |
|  |  |  |
| İPK CODE 14-1079 | İPK CODE 14-1080 | İPK CODE 14-1081 |
|  |  |  |
| İPK CODE 14-1082 | İPK CODE 14-1083 | İPK CODE 14-1084 |
|  |  |  |
| İPK CODE 14-1085 | İPK CODE 14-1086 | İPK CODE 14-1087 |

MUHTEL F MAK NA KAPAK LAST KLER

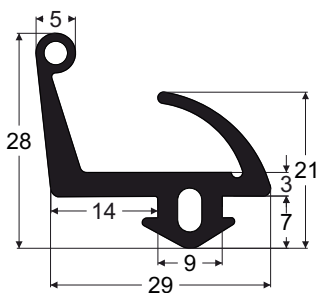
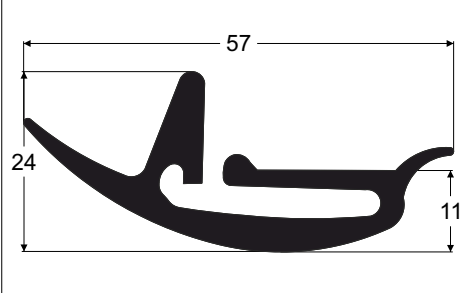
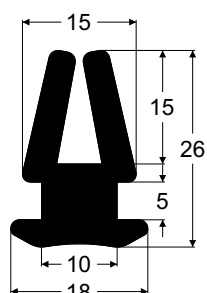
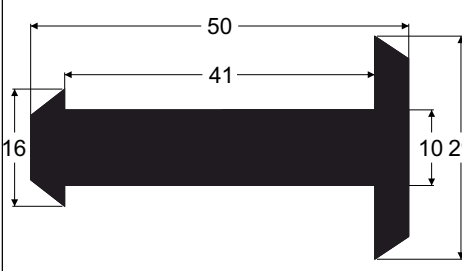
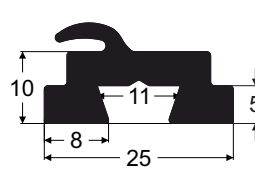
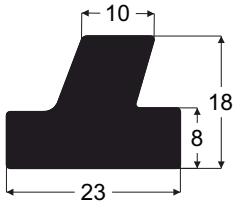
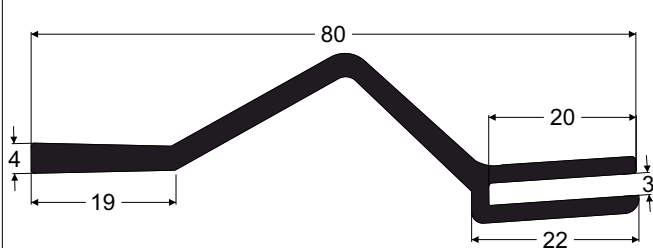
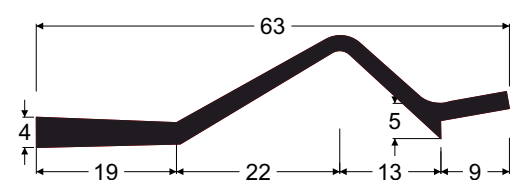
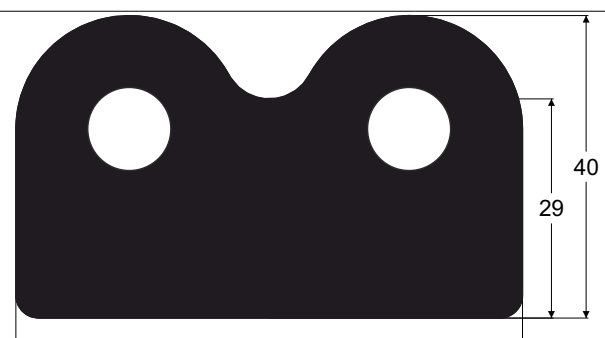
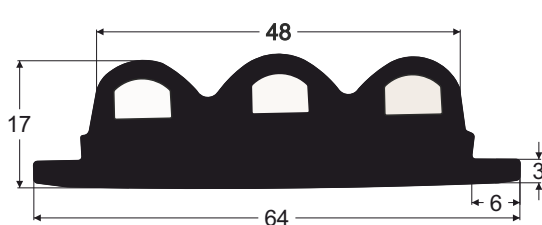
| | | |
|---|--|--|
|  |  |  |
| İPK CODE 14-1088 | İPK CODE 14-1089 | İPK CODE 14-1090 |
|  |  |  |
| İPK CODE 14-1091 | İPK CODE 14-1092 | İPK CODE 14-1093 |
|  |  | |
| İPK CODE 14-1094 | İPK CODE 14-1095 | |
|  |  | |
| İPK CODE 14-1096 | İPK CODE 14-1097 | |

MUHTEL F MAK NA KAPAK LAST KLER

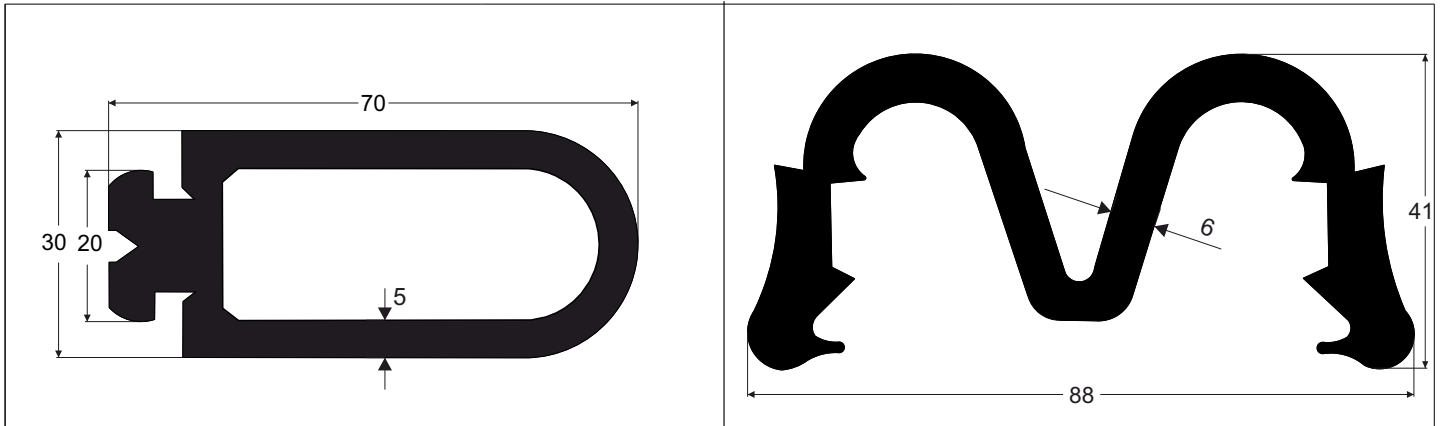

İPK CODE

14-1098

İPK CODE

14-1099

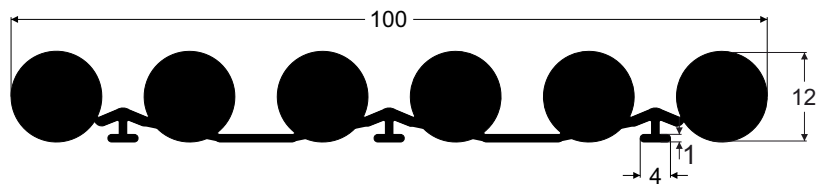

İPK CODE

14-1100

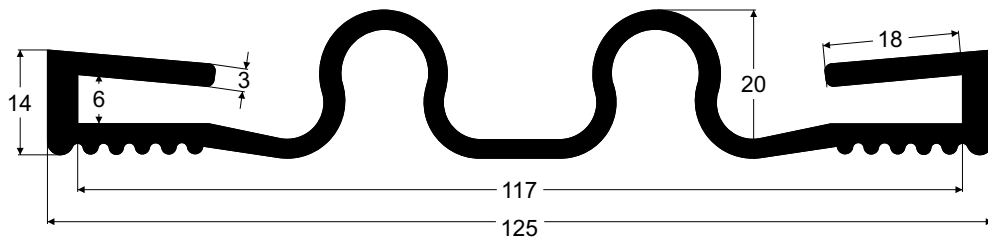

İPK CODE

14-1101

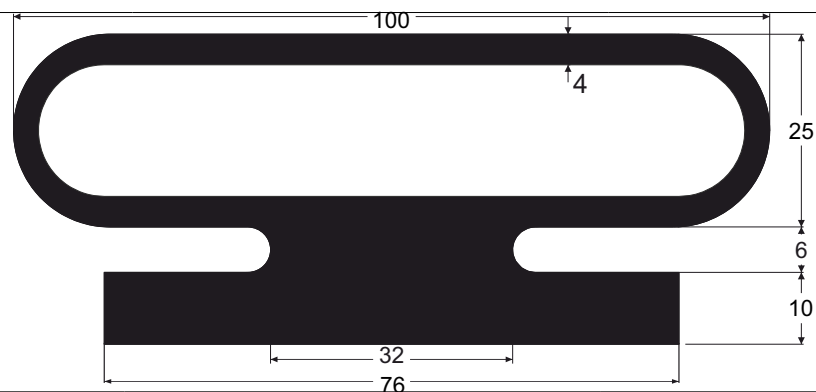

İPK CODE

14-1102



Ipekoğlu Otomotiv
KAUÇUK PLASTİK İNŞAAT GIDA VE TARIM ÜRL. SAN. TİC. LTD. ŞTİ.

Tel: +90 332 239 02 33 pbx Fax: +90 332 239 05 62

K.O.S. Reisköy Caddesi İnsu Sokak No: 1

Selçuklu - KONYA / TÜRKİYE

e-mail: ipekoglu@ipekoglu.com.tr

www.ipekoglu.com.tr